

# STIK S DOWN

LED GARDEN LIGHTS



## PLUS

Garden lights with height 40 cm with front light

Aluminium made

Replaceable led

## DIMENSIONS

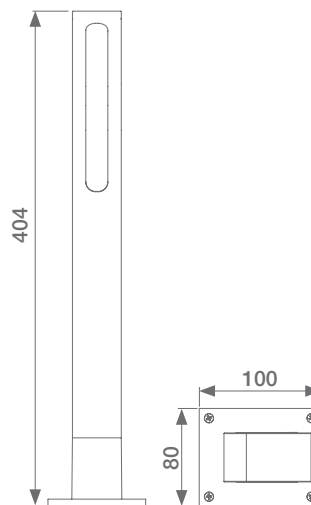

24-35Vdc

CRI>70

4400K

132lm

IP54

2W

## PHOTOMETRIC STIK S DOWN

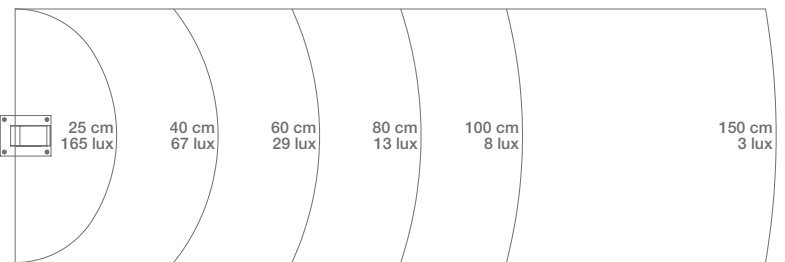
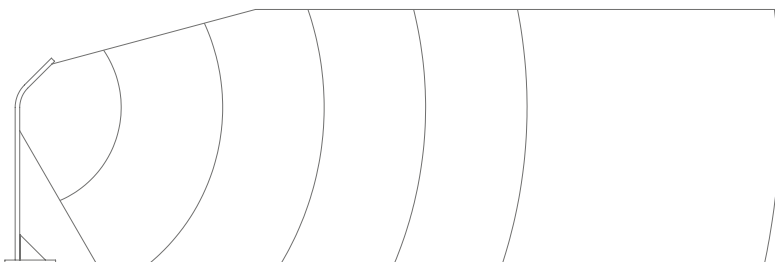

available colours:



WHITE RAL9010



BROWN RAL8019



GREY RAL7016

## MODELS

CODE	DESCRIPTION	WEIGHT
KSTIKDW	Pair of led garden lights, version DOWN, color WHITE RAL 9010. H= 404 mm	! 2PCS 1,7kg
KSTIKDB	Pair of led garden lights, version DOWN, color BROWN RAL 8019. H= 404 mm	! 2PCS 1,7kg
KSTIKDD	Pair of led garden lights, version DOWN, color GREY RAL 7016. H= 404 mm	! 2PCS 1,7kg

# STIK S UP

LED GARDEN LIGHTS



## PLUS

Garden lights with height 40 cm with back light

Aluminium made

Replaceable led

## DIMENSIONS

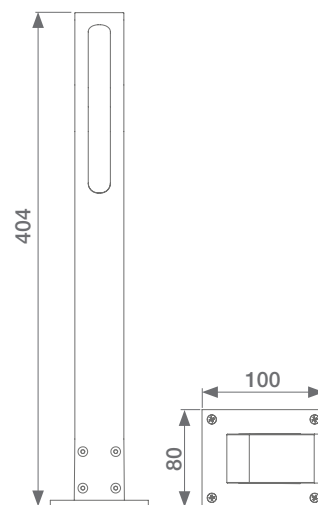

24-35Vdc

CRI>70

4400K

132lm

IP54

2W

## PHOTOMETRIC STIK S UP

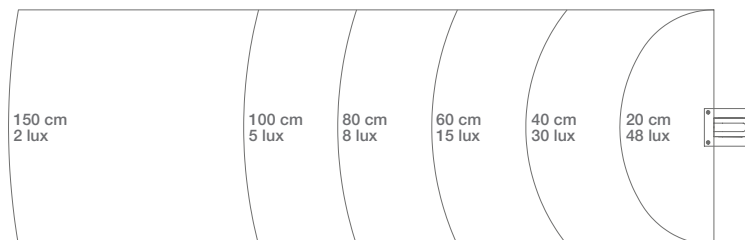

available colours:



WHITE RAL9010



BROWN RAL8019



GREY RAL7016

## MODELS

CODE	DESCRIPTION	WEIGHT
KSTIKUW	Pair of led garden lights, version UP, color WHITE RAL 9010. H= 404 mm	! 2PCS 1,7kg
KSTIKUB	Pair of led garden lights, version UP, color BROWN RAL 8019. H= 404 mm	! 2PCS 1,7kg
KSTIKUD	Pair of led garden lights, version UP, color GREY RAL 7016. H= 404 mm	! 2PCS 1,7kg

# STIK M

## LED GARDEN LIGHTS



### PLUS

Garden lights with height 75 cm with front light

Aluminium made

Replaceable led

### DIMENSIONS



24-35Vdc

CRI>70

4400K

132lm

IP54

2W

### PHOTOMETRIC

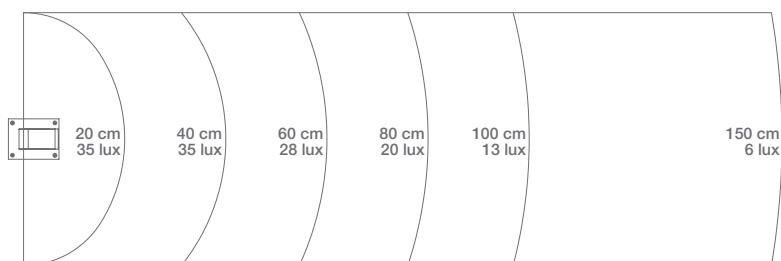
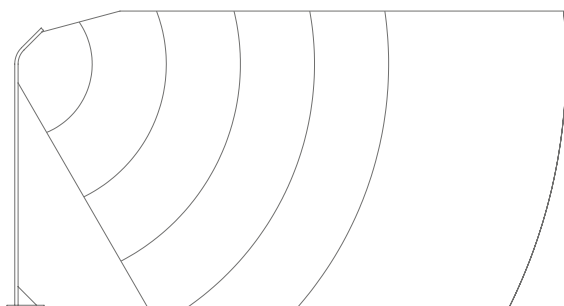

available colours:



WHITE RAL9010



BROWN RAL8019



GREY RAL7016

### MODELS

CODE	DESCRIPTION	WEIGHT
KSTIKMW	Pair of led garden lights, color WHITE RAL 9010. H= 750 mm	! 2PCS 2kg
KSTIKMB	Pair of led garden lights, color BROWN RAL 8019. H= 750 mm	! 2PCS 2kg
KSTIKMD	Pair of led garden lights, color GREY RAL 7016. H= 750 mm	! 2PCS 2kg

# FLAT

## LED GARDEN LIGHTS



### PLUS

Step lights, or for garage doors and pergolas

Aluminium made

### DIMENSIONS

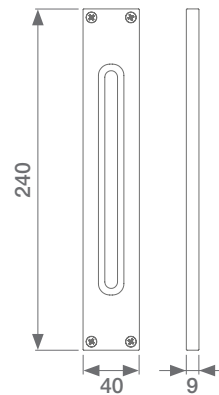

24-35Vdc

CRI>70

4400K

132lm

IP54

2W

### PHOTOMETRIC

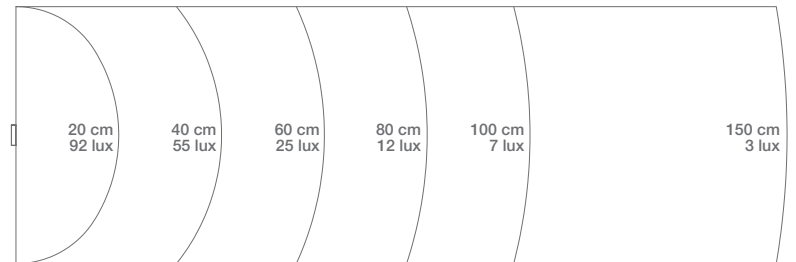
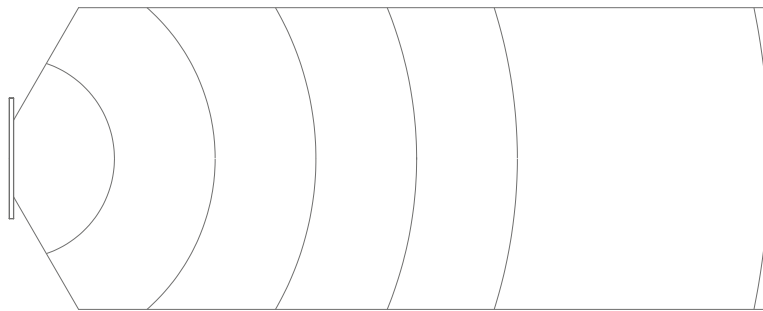

available colours:



WHITE RAL9010



BROWN RAL8019



GREY RAL7016

### MODELS

CODE	DESCRIPTION	WEIGHT
KSTIKFW	Pair of led garden lights, color WHITE RAL 9010. H= 240 mm	! 2PCS 1,7kg
KSTIKFB	Pair of led garden lights, color BROWN RAL 8019. H= 240 mm	! 2PCS 1,7kg
KSTIKFD	Pair of led garden lights, color GREY RAL 7016. H= 240 mm	! 2PCS 1,7kg

# VERTICAL

## LED GARDEN LIGHTS



### PLUS

Lights for pedestrian or vehicular access, to be installed on top of the fence

Aluminium made

Replaceable led

### DIMENSIONS

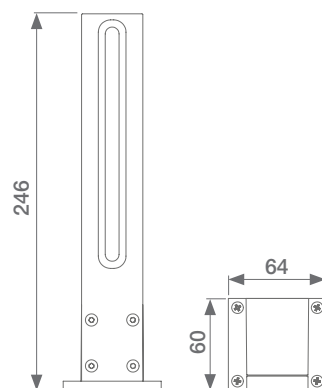

24-35Vdc

CRI>70

4400K

132lm

IP54

2W

### PHOTOMETRIC

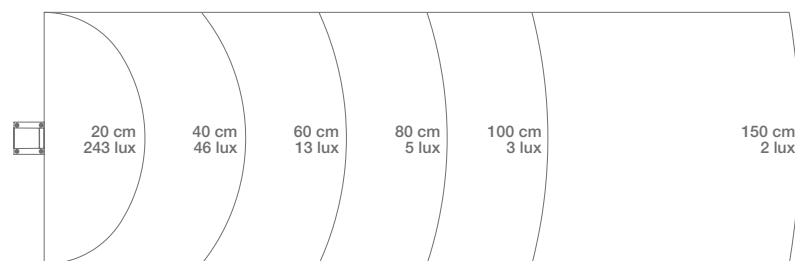

available colours:



WHITE RAL9010



BROWN RAL8019



GREY RAL7016

### MODELS

CODE	DESCRIPTION	WEIGHT
KSTIKVW	Pair of led garden lights, color WHITE RAL 9010. H= 246 mm	! 2PCS 1,7kg
KSTIKVB	Pair of led garden lights, color BROWN RAL 8019. H= 246 mm	! 2PCS 1,7kg
KSTIKVD	Pair of led garden lights, color GREY RAL 7016. H= 246 mm	! 2PCS 1,7kg

# TOWER

## LED GARDEN LIGHTS



### PLUS

Lights with double led strip, suitable for parking lots and public areas

Aluminium made

Replaceable led

### DIMENSIONS

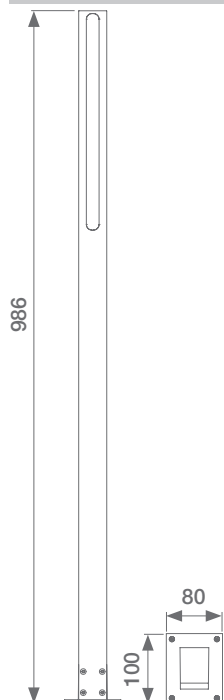

24-35Vdc

CRI>70

4400K

264lm

IP54

4W

### PHOTOMETRIC

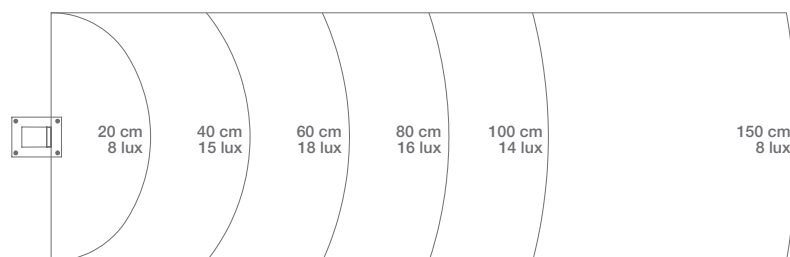
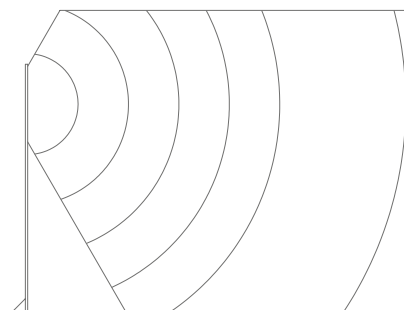

available colours:



WHITE RAL9010



BROWN RAL8019



GREY RAL7016

### MODELS

CODE	DESCRIPTION	WEIGHT
KSTIKTW	Pair of led garden lights, color WHITE RAL 9010. H= 986 mm	! 2PCS 2,7kg
KSTIKTB	Pair of led garden lights, color BROWN RAL 8019. H= 986 mm	! 2PCS 2,7kg
KSTIKTD	Pair of led garden lights, color GREY RAL 7016. H= 986 mm	! 2PCS 2,7kg

# STELLA

## LED GARDEN LIGHTS



### PLUS

Led lights to light up large areas

Aluminium made, H= 600 mm, 986 mm

Replaceable led

### LIGHT BEAM CONFIGURABLE AT WILL

STANDARD

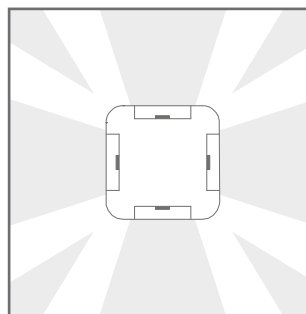

ANGULAR

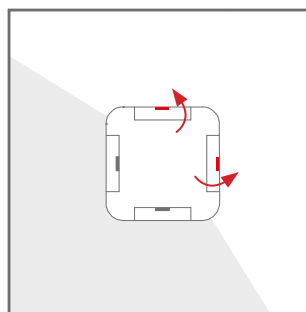

LINEAR

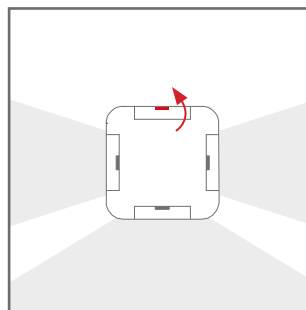

24-35Vdc

CRI>70

4400K

264lm

IP54

8W

### MODELS

CODE	DESCRIPTION	WEIGHT
ST60	Led garden lights, color GREY RAL 7016. H= 600 mm	! 1PC 3,7kg
ST100	Led garden lights, color GREY RAL 7016. H= 986 mm	! 1PC 5,1kg

## ACCESSORIES



**KST11**  
Pair of tip for soil  
fixing

PC 1

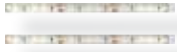

**999LED**  
Pair of led lights  
neutral white  
(standard)

PC 1

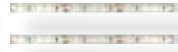

**999LEDW**  
Pair of led lights  
warm white

PC 1

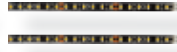

**999LEDB**  
Pair of led lights  
neutral white  
(standard)

PC 1

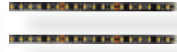

**999LEDBW**  
Pair of led lights  
warm white

PC 1



**3MJ**  
Pre insulated  
self-stripping  
connector (max  
size 1,5 mm<sup>2</sup>)  
PCS 50



# BOXLED

MAIN BOARD FOR LED LIGHTS CONTROL



## PLUS

Developed for the automatic control of LED lights, to illuminate the area around the gate entry, frames and driveways

4 independent outputs to control up to 15 lights each (60 lights total)

Output for night sensor QUADRO

Built-in receiver

Possibility to use 3 different outputs to control RGB lights

Programming with buttons or via display DYL

### Main features:

- 4 led outputs
- 750mA per output (max. with 15 lights) with overload protection
- output for external light sensor
- display connection DYL (optional)
- built-in radio receiver
- suitable up to 30 codes
- output leds
- fast programming button
- external antenna onboard
- 230Vac

## MODELS

CODE	DESCRIPTION
BOXLED	Key Automation led light control unit 24Vdc

### BOXLED

#### ELECTRICAL DATA

power supply	Vac	230 ± 10%
max power	W	100
power stand-by	W	<0,5
maximum output load	24Vdc	fifteen 18-led strips for each of the 4 outputs / thirty 18-led strips for 2 outputs (CH1-CH4) CH1=20W (MAX 40W) CH2=20W CH3=20W CH4= 20W (MAX 40W) TOT=80W MAX

#### GENERIC DATA

protection degree	IP	54
dimensions (L - D - H)	mm	222 - 110 - 275
operating temperature	°C	-20 + 55
max. number of transmitters storage FIX CODE		30 transmitters
max. number of transmitters storage ROLLING CODE		30 transmitters

## ACCESSORIES



**QUADRO**  
Night sensor

PC 1



**DYL**  
Display module  
Cable length  
120 cm

PC 1



**RX2H**  
Miniaturised  
control unit

PC 1

## KIT



### GARDEN KIT AUTOMATIC GARDEN LIGHT KIT

#### Composition:

- BOXLED (1 pc)
- PLAY4R (1 pc)
- QUADRO (1 pc)

**ADD THE LED GARDEN LIGHT OF YOUR CHOICE!**  
(not included)

**KBOXLED**